



Strain and resonance energies in main-group homoatomic rings and clusters

Benjamin M. Gimarc *, Ming Zhao

Department of Chemistry and Biochemistry University of South Carolina, Columbia, SC 29208, USA

Received 14 December 1995; accepted 25 January 1996

Contents

Abstract	385
1. Introduction	386
2. Calculations	387
3. Strain energies of homoatomic rings	388
3.1. Rings of single bonds only	388
3.2. Rings containing one double bond	392
4. Strain energies of some polyhedral homoatomic clusters	393
4.1. Four-atom clusters	395
4.2. Six-atom clusters	398
4.3. Eight-atom clusters	403
5. Additivity rule for ring strain energies	406
5.1. Strain energy additivity in silicon clusters	407
5.2. Strain energy additivity in Group 15 clusters	408
6. Summary	409
Acknowledgements	410
References	410

Abstract

A summary of recent progress in the estimation of strain and resonance energy parameters that apply to structures composed of representative elements other than carbon, including silicon, nitrogen, phosphorus, oxygen, sulfur and, to a limited extent, arsenic. © 1997 Elsevier Science S.A.

Keywords: Ring strain energies; Resonance energies; Clusters

* Corresponding author.

1. Introduction

The bond additivity or localized bond model has been extremely useful in understanding and rationalizing much of chemistry [1,2]. The observations that bonds between pairs of atoms can be classified as different types of qualitatively different bond order (single, double, and triple bonds) and that these bond types and their corresponding properties (such as bond energies and bond distances) can pass virtually unchanged from one molecule to another provide quick estimates of energy changes in chemical reactions, estimates of energies of activated complexes, and relative energies of structural isomers. Estimates of reaction energy changes based on values of average bond energies and numbers of different kinds of bonds lost and gained can be refined by incorporating corrections for various substituent groups. More substantial deviations from the bond additivity rule can be accounted for by introducing the concepts of strain and resonance. Structural clues warn us when deviations due to these effects are likely to occur and, at least for a number of examples from organic chemistry, we have at hand rather well-established values of strain energies and resonance energies to apply as corrections to the additivity or localized bond results. This review summarizes recent progress in the estimation of strain and resonance energy parameters that apply to structures composed of the representative elements other than carbon. Our investigations have been restricted to the elements silicon, nitrogen, phosphorus, oxygen, sulfur and, to a limited extent, arsenic. We have chosen a set of benchmark structures that are well represented in organic chemistry. Although inorganic examples of these structures are few, the comparisons with hydrocarbons and among themselves provide a basis for realizing and rationalizing trends as they operate differently among similar structures composed of different elements.

Strain is a destabilizing effect that arises when the structural requirements in a molecule produce distortions from their preferred values of bond angles, bond distances, and rotational conformations about bonds [1,3–6]. Angle strain usually results when the ends of a chain of atoms are joined to form a ring or when large bulky groups attached to the same atom try to avoid each other, stretching bonds and distorting angles between bonds at individual atoms. Structural requirements might also displace substituent atoms or lone pairs of electrons at the opposite ends of a bond from optimal conformational orientations with respect to one another, perturbing preferred dihedral or torsional angles. In addition, the structural requirements of a ring might move substituent groups or lone pairs together across the ring and into less favorable positions with respect to each other than are available to these groups on a chain-type structure.

Resonance is another expression of failure of the localized bond model. This effect is ascribed to the delocalization of electrons in the π components of double bonds. Possibilities for delocalization are readily recognized; they usually occur in systems with conjugated double bonds. Resonance usually makes the molecule more stable than anticipated from the bond additivity model. Aromaticity is a particularly strong resonance stabilization due to the delocalization of π electrons around a ring [7–9].

Significant extra stabilization can be expected in rings containing Hückel numbers of π electrons, $4n+2$, $n=0, 1, 2, \dots$

2. Calculations

Several methods have been proposed for the definition and calculation of strain energies [1,3–6]. The scheme we describe here can be conveniently based on experimental heats of formation or on total molecular energies obtained from *ab initio* molecular orbital (MO) calculations. Strain energies can be calculated as energy changes for reactions that convert rings and polyhedral structures into chains, thereby releasing or relieving strain. In a similar fashion, reactions that open aromatic rings, disrupting cyclic conjugation, can be used to estimate resonance stabilization. For many hydrocarbon molecules the heats of formation for reaction products and reactants are available and strain and resonance energies can be calculated directly from thermochemical data. Comparable experimental quantities for inorganic rings and clusters are not usually known, but we estimate the energy changes of appropriate reactions by taking differences in product and reactant total energies as obtained from geometry optimized *ab initio* MO calculations [10,11]. These energy changes are small differences between quantities of enormous magnitude which themselves contain huge errors due to choice of basis set and electron correlation. The results summarized here were obtained with basis sets at least as good as 6-31G**, which includes a split valence or double- ζ representation of valence shell atomic orbitals and contains a set of three p-type polarization functions on each hydrogen atom and a set of six d-type polarization functions on each main-group atom. The d-type polarization functions are known to be essential for the accurate description of the structures of molecules containing elements such as silicon, phosphorus, and sulfur. Total energies calculated at the restricted Hartree–Fock (RHF) level have been corrected for electron correlation to second order by Møller–Plesset perturbation theory (MP2). The resulting total energies still have basis set and correlation errors. Strain energies are calculated as energy differences for chemical reactions and we can hope to make inherent errors in total energies largely cancel when energy differences are taken if we choose reactions that involve minimal differences in the electronic structures of reactants and products. A reaction is said to be homodesmotic if it conserves bond types and maintains the valence environment around each atom [12–14]. These conservation properties suggest that localized basis set and correlation errors in total energies of reactants and products are more likely to be about the same and therefore should approximately cancel when energy differences are taken [15].

Because the homodesmotic reaction conserves bond types, the bond additivity model predicts the corresponding energy change to be zero. However, if the reaction converts cyclic molecules into chains, thereby releasing strain energy, we would expect the reaction to be exothermic by an amount equal to the strain energy. We have chosen to represent strain energy, a destabilizing quantity, as positive with sign opposite to that of the calculated energy change for the strain-releasing reaction.

Resonance energies can also be represented as energy changes that accompany homodesmotic reactions that convert aromatic rings into chains that might themselves involve some delocalization [16]. Since resonance usually provides extra stabilization for the cyclic structure, we anticipate the corresponding homodesmotic reaction to be endothermic. We report resonance energy as a negative quantity.

3. Strain energies of homoatomic rings

3.1. Rings of single bonds only

Eq. (1) is a general reaction that converts rings of sulfur atoms into chains:

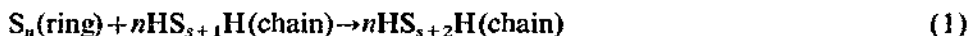

One can think of this process as disassembling the S_n ring into n individual sulfur atoms, each of which is then inserted into a chain, $HS \cdots SH$, to make the chain one atom longer. The parameter $s = -1, 0, +1, \dots$ determines the length of the chain and gives special properties to the reaction. For $s = +1$, the reaction is homodesmotic, conserving bond types and the valence environment at each atom [12–14]. For $s = 0$, the reaction conserves bond types but not atomic valence environments and it is said to be isodesmic [10]. With $s = -1$, neither bond types nor valence environments are conserved but numbers of electron pairs are conserved and the reaction is called isogyric [10]. Obviously, a long chain should be able to incorporate an additional atom with less disruption to its electronic structure so large values of s would appear to be preferred. How long must the chain be to give reaction energy changes that are independent of the parameter s ? Fig. 1 shows trends in calculated strain energies as energy changes for Eq. (1) for sulfur rings of ring size n and chain length parameter s . For $s \geq +1$, strain energies for the same size ring differ from each other by no more than 1 or 2 kcal mol⁻¹ [17]. Experience with comparable processes for the ring systems $(CH_2)_n$, $(SiH_2)_n$, $(NH)_n$, $(PH)_n$, and O_n shows the same requirement of $s \geq +1$ [18–22].

How well do strain energies calculated as energy changes for Eq. (1) using ab initio total energies agree with values obtained with experimental data? Thermochemical heats of formation are available for sulfur rings, $n \geq 6$, and chains [23–25] and for alkanes and cycloalkanes, $n \geq 3$ [1]. Strain energies based on ab initio calculated total energies and on experimental data agree to within a few kilocalories per mole. Fig. 2 compares strain energies of the cycloalkanes calculated as energy changes for the hydrocarbon analog of Eq. (1), $s = +1$, using experimental heats of formation and using ab initio total energies calculated at the MP2/6-31G** level. The ab initio results lie about 4 kcal mol⁻¹ above the experimental track and show parallel trends.

To what extent does the choice of chain-terminating group affect the strain energy? In Eq. (1) the sulfur chains are terminated by hydrogen atoms. The effect of terminal groups might conceivably be significant. It is recognized, for example, that the O–O bond in HOOH is quite different from that in FOOH. Calculations of O_n ring strain

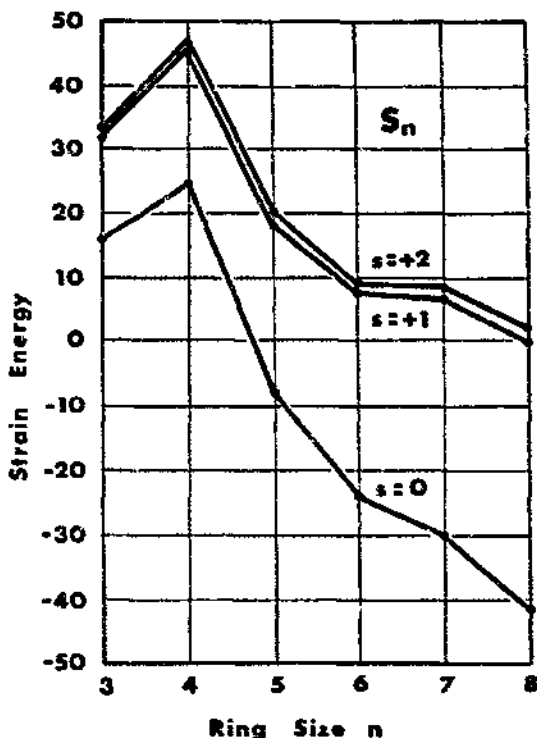

Fig. 1. Strain energies of sulfur rings S_n , as functions of ring size n and the chain length parameter s . For $s \geq +1$, strain energies for the same n differ by at most 1 or 2 kcal mol⁻¹.

energies using oxygen analogs of Eq. (1), but employing H, F, and Cl as chain-terminating atoms, give essentially the same results for each ring size n [19]. The choice of chain-terminating group does not significantly influence the calculated ring strain energy.

We have reported strain energy calculations following analogs of Eq. (1) for $(CH_2)_n$, $(SiH_2)_n$, $(NH)_n$, $(PH)_n$, O_n , and S_n [17-22]. Results are collected in Table 1 and summarized in Fig. 3.

The cycloalkanes $(CH_2)_n$ are familiar compounds. Silicon and phosphorus are known to form rings, although perhaps carrying substituents other than hydrogen [26,27]. Sulfur forms rings for $n \geq 5$ [28-37]. O_n and $(NH)_n$ rings are unknown, but it is instructive to include them for comparisons. Fig. 3 reveals several interesting similarities and differences among the various series. First, one would expect that strain would be relieved as the ring expands from $n=3$ to $n=4$ as bond angles open from 60° to something near 90° , an angle much closer to the 109.5° value anticipated for bonds around an sp^3 hybridized ring atom. A sizable decrease in strain actually occurs only for the cyclosilanes [38]. Among the hydrocarbons, the strain energy of cyclobutane is only slightly less than that of cyclopropane, and not the large drop

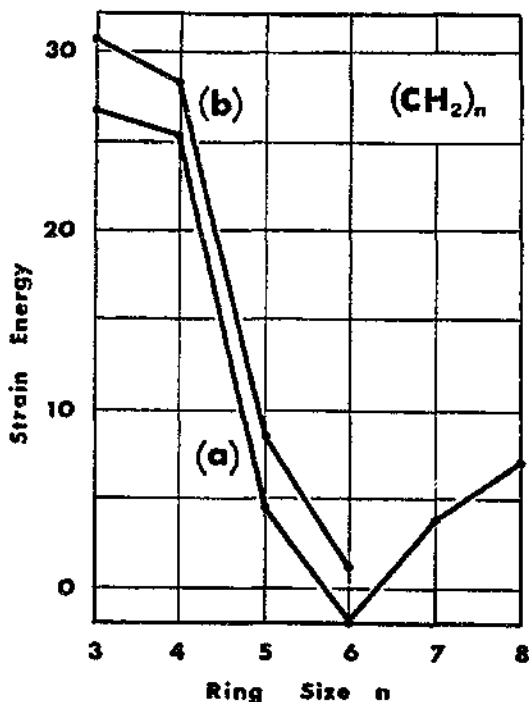

Fig. 2. Strain energies (kcal mol⁻¹) of the cycloalkanes (CH₂)_n calculated as energy changes for a homodesmotic reaction analogous to Eq. (1) using (a) experimental heats of formation, and (b) total energies MP2/6-31G**.

Table 1

Strain energies (kcal mol⁻¹) of monocycles containing all single bonds; results are for the lowest energy ring conformations

Ring size	(CH ₂) _n	(SiH ₂) _n	(NH) _n	(PH) _n	O _n	S _n
3	30.8	38.3	30.1	10.8	23.0	32.0
4	28.5	17.0	37.2	14.0	44.7	46.7
5	8.3	6.0	10.2	-3.5	18.1	20.0
6	1.4	1.4	10.8	0.0	9.1	9.1
7			29.9	19.2	8.9	8.6
8			29.1	8.4	1.6	2.2

the figure shows between (SiH₂)₃ and (SiH₂)₄. We think this points to an unusual stability for cyclopropane. The nitrogen, phosphorus, oxygen, and sulfur series all show a strain energy maximum at *n*=4, with the peaks for sulfur and oxygen being much higher than those for nitrogen and phosphorus. We attribute the *n*=4 maximum for rings from Groups 15 and 16 as the results of non-nearest-neighbor lone-pair–lone-pair repulsions that occur in four-membered rings but not in three-memb-

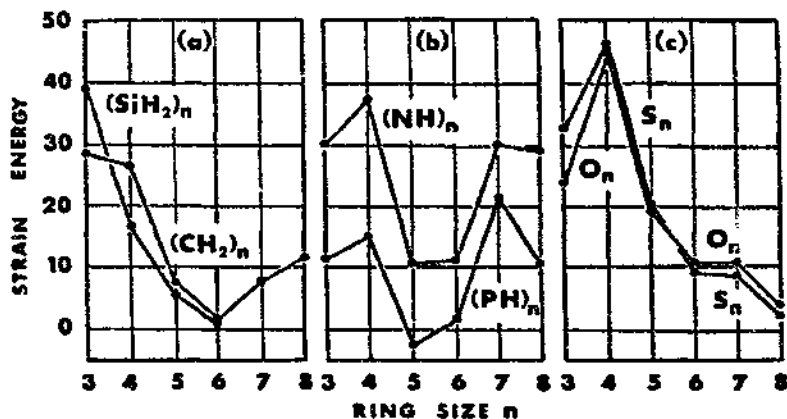
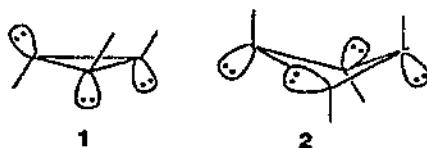

Fig. 3. Strain energies (kcal mol^{-1}) of all-single-bond monocycles as functions of ring size n .

ered rings. Structures 1 and 2 represent the arrangements of lone pairs in the lowest energy conformers of $(\text{NH})_3$ and $(\text{NH})_4$.



For $n \geq 4$, several different conformers are possible for each n in $(\text{NH})_n$ and $(\text{PH})_n$ rings. Relative energies of the different conformers can be rationalized on the basis of the 'gauche effect', which specifies that lone pairs at opposite ends of a bond prefer to be approximately 90° apart [39]. It is possible to obtain strain energies of high energy conformers from results reported previously, and those quantities are useful in specific instances. The ring atoms in O_n and S_n have twice as many lone pairs as those in $(\text{NH})_n$ and $(\text{PH})_n$, and therefore should have even higher peaks at $n=4$, as demonstrated in Fig. 3.

Fig. 3 also shows that, with the exception of $(\text{SiH}_2)_3$, strain energies of Si and P rings fall well below those of rings of the same size for C and N. Lower strain energies for rings composed of elements from lower rows of the periodic table would appear to be consistent with the electronic structures of those rings being described by valence MOs composed of valence AOs of larger principal quantum number, orbitals that are larger and more diffuse and which form bonds that are weaker and have lower angular preference. But what about the rings of sulfur and oxygen? The strain energy curves for these two series lie almost on top of each other.

Different families of elements achieve minimum strain energies at different ring sizes. For Group 14, $(\text{CH}_2)_n$ and $(\text{SiH}_2)_n$, lowest strain energies are for the six-membered rings. For Group 15, minimum strain occurs for $n=5$ and 6. For Group 16, eight-membered rings have the least strain.

Table 2

Strain energies (kcal mol⁻¹) of monocycles containing one double bond; also included for nitrogen and phosphorus are values for the higher energy conformers, **4b** and **5b**, that occur as fragments of polyhedral clusters

Ring size	C _n H _{2n-2}	Si _n H _{2n-2}	N _n H _{n-2}	P _n H _{n-2}
3	54.5	37.2	40.5	7.9
4	30.6	12.6	31.9/40.1	7.4/16.2
5	6.8	2.1	12.9/32.3	4.5/3.6

3.2. Rings containing one double bond

Eq. (2) is a homodesmotic reaction that relieves the strain in cyclopropene. The double bond is transferred to the product 2-butene while the methylene group of cyclopropene ends up in the middle of the propane product.

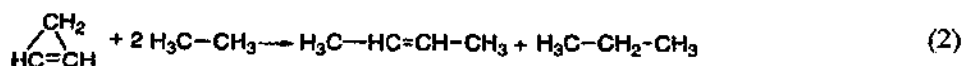

Comparable reactions can be written for the other cycloalkenes and the cyclosilenes, C_nH_{2n-2} and Si_nH_{2n-2}, and for the one-double-bond-containing rings N_nH_{n-2} and P_nH_{n-2}. Strain energies for these four series, *n* = 3–5, appear in Table 2. Fig. 4 displays the trends.

The cycloalkene strain energies were calculated from thermochemical heats of formation [1] following homodesmotic reactions comparable with Eq. (2). The other strain energies are based on ab initio total energies. Nitrogen and phosphorus are each represented by two curves corresponding to different conformations of the four- and five-membered rings that involve different relative orientations of substituent hydrogens and lone pairs. Only one conformation, **3**, is possible for the three-membered rings of N and P. Structures **4a** and **5a** represent the low energy conformers of the four- and five-membered rings. Higher energy conformers **4b** and **5b** are of interest because they approximate the arrangements of bonds and lone pairs in

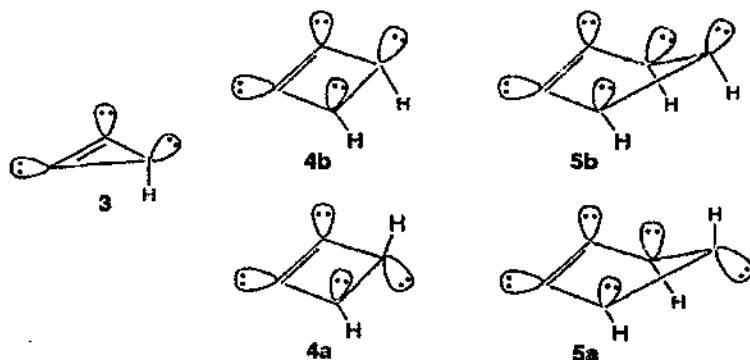

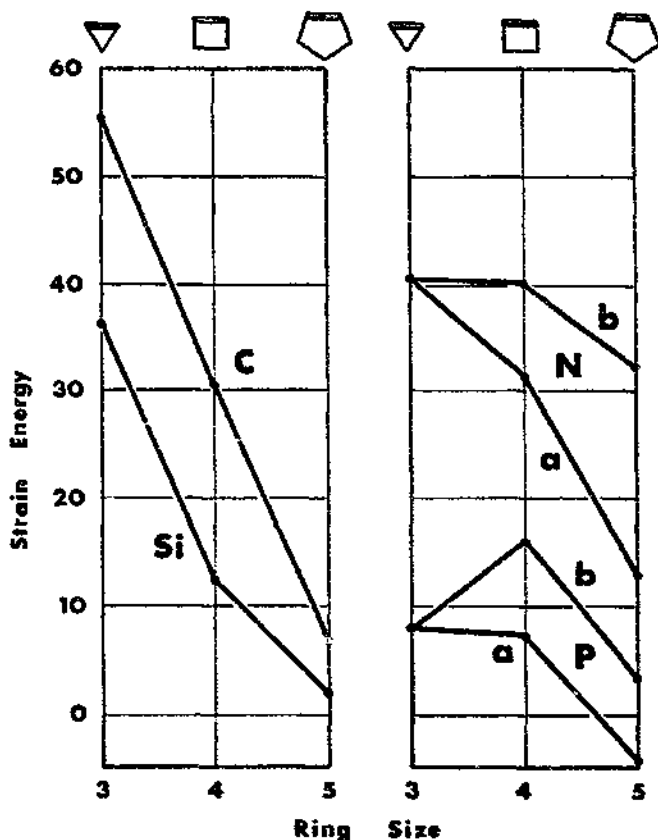

Fig. 4. Strain energies (kcal mol^{-1}) of rings containing one double bond. For N and P, two curves follow different ring conformations. Curve (a) tracks the lowest energy conformations, while curve (b) corresponds to conformations that approximate fragments occurring in polyhedral structures.

fragments of nitrogen and phosphorus polyhedral clusters to be considered in the next selection.

Fig. 4 shows that strain energies of silicon and phosphorus rings are much smaller than those of carbon and nitrogen. The differences between curves (a) and (b) for different conformations of nitrogen and phosphorus rings give an idea of energy differences that must be attributable to differences in lone-pair–lone-pair repulsions, 10 to 20 kcal mol^{-1} in the case of nitrogen and considerably less for phosphorus.

4. Strain energies of some polyhedral homoatomic clusters

Many of our ideas of structure and bonding in the representative elements come from the enormous variety of compounds in which a set of carbon atoms forms the structural framework of the molecule. These hydrocarbon structures establish our expectations of plausible structures for homoatomic clusters of other main-group

elements. In this section we compare relative energies and strain energies of proposed homoatomic clusters of $(\text{SiH})_{2n}$, N_{2n} , P_{2n} , and As_{2n} with those of well-established or imagined isoelectronic benchmark hydrocarbon clusters $(\text{CH})_{2n}$, $n=2, 3$, and 4. These are the hydrocarbon valence isomers in which $2n$ CH units are connected by CC single and double bonds according to normal valence rules to form polyhedral structures. They have been enumerated by Balaban [40]. We will consider only a limited set of these structures, 6-14.

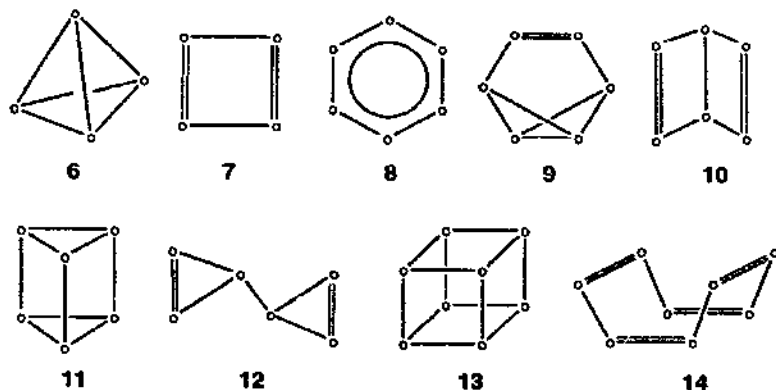

For computational convenience, optimization of structural parameters usually takes place assuming a structure of a particular symmetry point group. If the calculated vibrational frequencies for the structure turn out to be all real numbers, then the structure corresponds to a minimum on the energy surface. If one or more vibrational frequencies is imaginary, then the structure is not a minimum. Structures that are found to be minima on the RHF energy surface may not be minima on the MP2 surface. The questions of energy surface minima invite elaboration. Although the planar rectangle 7 is a minimum at both RHF and MP2 levels of theory for $(\text{CH})_4$ [41] and N_4 [42], this structure is not a minimum on either surface for $(\text{SiH})_4$ [43]. The tetrahedron 6 is a minimum for $(\text{SiH})_4$ on the RHF surface but not for MP2. Relaxing T_d symmetry constraints for MP2 calculations for $(\text{SiH})_4$ leads to a non-planar, puckered square minimum of D_2 symmetry that is tens of kilocalories per mole below the energy of the regular tetrahedron [43,44]. Neither $(\text{CH})_4$ nor N_4 has a puckered square minimum at either level of theory. The regular planar hexagonal D_{6h} form 8 of N_6 is a minimum under the RHF approximation but not at the MP2 level for which the less constrained D_2 structure is a minimum and only 2.5 kcal mol⁻¹ lower than planar 8 [45-47]. In these and other structures, silicon shows the largest number of deviations from our expectations based on the benchmark hydrocarbons. For $(\text{SiH})_6$ the planar benzene structure 8 is not a minimum on either RHF or MP2 energy surface. At the MP2 level the energy minimum for a slightly less constrained D_{3d} structure lies only 4 kcal mol⁻¹ below that of 8 [48,49]. The benzvalene structure 9 of N_6 is a minimum for RHF calculations but, on optimization under C_{2v} symmetry at the MP2 level, this structure attempts to dissociate into the fragments N_2 and bicyclobutane N_4 [45-47]. The $(\text{SiH})_6$ Dewar benzene 10 is not a minimum under C_{2v} symmetry constraints on the MP2 surface

[22]. We think this is a computational artefact, because calculations under reduced symmetry constraints led back to **10**. Furthermore, preparation of $(\text{SiR})_6$ **10** has been reported as a thermally labile compound that readily converts to **11** [50]. Could substituents R induce an energy minimum for a structure where none existed for the parent compound? An example of such behavior has been studied for another silicon cluster, tetrasilabicyclobutane, Si_4R_6 [51]. Although some of the structures **6-14** may not correspond to energy minima for several specific clusters, we have considered them all here anyway because these structures are pervasive in our thinking about molecular properties.

For total energies and strain energies of $(\text{CH})_6$ **8-12** we have used values reported by Schulman and Disch [52]. Hess and Schaad have published total energies of **6** and **7** [41]. We use estimates of strain energy of $(\text{CH})_4$ **6** calculated by Schulman and Venanzi [53]. Strain energies of N_4 **6** and **7** and N_6 **8-12** are based on ab initio total energies reported by Glukhovtsev and Schleyer [42,45] and by Engelke [46,47]. Nagase has calculated strain energies of **6**, **11**, and **13** for the Group 14 hydrides (C, Si, Ge, Sn, and Pb) [54].

4.1. Four-atom clusters

Although the $(\text{CH})_4$ parent hydrocarbons tetrahedrane **6** and cyclobutadiene **7** have eluded attempts at preparation, compounds containing the four-carbon atom tetrahedral and planar rectangular core structures have been realized by stabilizing them with bulky substituent groups [55,56]. Ab initio calculations for $(\text{CH})_4$ give bond distances in **7** that correspond to pairs of C-C single and C=C double bonds of lengths within established norms for such bonds for carbon. At the MP2 level the rectangle **7** is higher in energy than the tetrahedron **6** by $12.4 \text{ kcal mol}^{-1}$ [41].

The structures of the Group 15 clusters P_4 , As_4 , Sb_4 , and Bi_4 have long been known to be tetrahedral **6** [57-60]. No planar rectangular isomeric structures have been reported. At the level of the bond additivity model, the energy difference between **6** and **7** is the result of different numbers of different kinds of bonds; **6** is connected by six single bonds, whereas **7** consists of two single and two double bonds. Therefore, the energy difference between **6** and **7** is just 2Δ , where $\Delta = 2D(\text{X-X}) - D(\text{X=X})$ is the difference between the energies of two single bonds and one double bond. Table 3 contains values of average bond energies of the main-group elements we consider here. The values for carbon are taken from a convenient source [61].

We obtained the remaining values by assuming standard bond energies for N=N, Si-Si, P-P, and As-As and calculating the energies of the corresponding bonds (N=N, Si=Si, P=P, and As=As) by applying a value of Δ calculated from ab initio total energies as the energy change for an isogyric reaction analogous to the one involving phosphorus in Eq. (3):

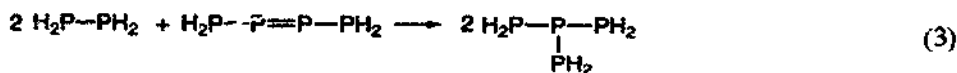

Table 3

Average bond energies (kcal mol⁻¹) for homoatomic single and double bonds. $D(X-X)$ and $D(X=X)$ and the quantity $\Delta = 2D(X-X) - D(X=X)$

Bond	Energy	Δ	Bond	Energy	Δ
C-C	83	20	N-N	43	-14
C=C	146		N=N	100	
Si-Si	74	47	P-P	55	24
Si=Si	101		P=P	86	
			As-As	43	26
			As=As	60	

Double bond energies of Group 14 and 15 elements from the lower periods are not established. These choices make the ab initio calculated strain energies of the benchmark structures consistent with the calculated relative energies of these structures. The energy differences among benchmark isomers are just energy changes for isogyric isomerization reactions.



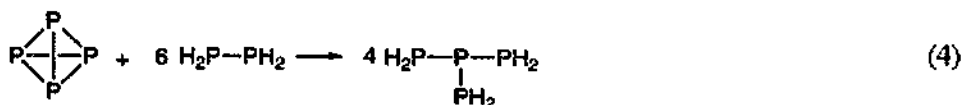

For C, Si, P, and As, two single bonds are stronger than a double bond and Δ is positive. The reverse is true for nitrogen; Δ is negative. For P₄, the bond additivity model predicts **6** to be more stable than **7** by $2\Delta = 48$ kcal mol⁻¹. Experience suggests that both structures will be destabilized by strain, probably to different extents. The strain energy of tetraphosphorus cyclobutadiene **7** can be calculated as the energy change for a homodesmotic reaction that can be written in analogy to Eq. (2). Eq. (4) is a homodesmotic reaction that relieves the strain in tetraphosphorus tetrahedrane **6**:

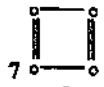

The conservation of bond types in Eq. (4) gives an energy change of zero for this reaction from the bond additivity model, but the reaction can be expected to be exothermic as a result of the release of strain in tetrahedral P₄. Keep in mind, however, that the product P(PH₂)₃ is a branched molecule that might still include some strain compared with the unbranched chains that result from the opening of monocycles in Eqs. (1) and (2). Table 4 collects strain energies of these and other polyhedral clusters [62-65].

Fig. 5 compares relative energies and strain energies of tetrahedral **6** and planar rectangular **7** structures for N₄, P₄, and As₄. For each element, level A represents the relative energies of the two structures based on differences in average bond energies only. For P₄ and As₄, the cyclobutadiene structure is higher than the

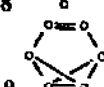
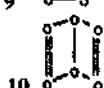
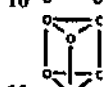
Table 4
Strain energies (kcal/mol) of polyhedral homoatomic clusters

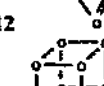
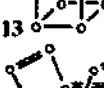
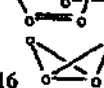
Structure	Carbon	Silicon	Nitrogen	Phosphorus	Arsenic
	141	135.0	56.1	19.7	12.6
	78	38.7	95.4		
	-24.7	-15.1	19.8	-14.9	-17.4
	81.3	68.7	97.3	20.8	12.4
	63.6	26.2	88.6	13.1	2.2
	148.9	110.0	144.1	52.9	32.7
	107.2	72.5	84.6	15.7	7.4
	165.1	94.5	219.4	75.8	43.6
	2.1	-4.2	92.8		
	66.5	54.0	64.2		

tetrahedrane structure by 2*A*; two double bonds are weaker than four single bonds by 48 and 52 kcal mol⁻¹ respectively. For N₄ at the A level, the order is reversed; cyclobutadiene is more stable than tetrahedrane because NN double bonds are stronger than pairs of single bonds. Level B shows the relative energies of structures as established by *ab initio* calculations and indicates the amounts by which both structures are destabilized by strain.

Generally, the strain energies of the cyclobutadienes are larger than those of the corresponding tetrahedranes and strain energies decline markedly from N₄ to P₄ and As₄. For N₄, the strain energies of 6 and 7 are much larger than 2*A* for nitrogen bonds, with the result that the relative strain energies determine the relative isomer energies, 7 above 6, as determined by *ab initio* calculations, level B. For P₄ and

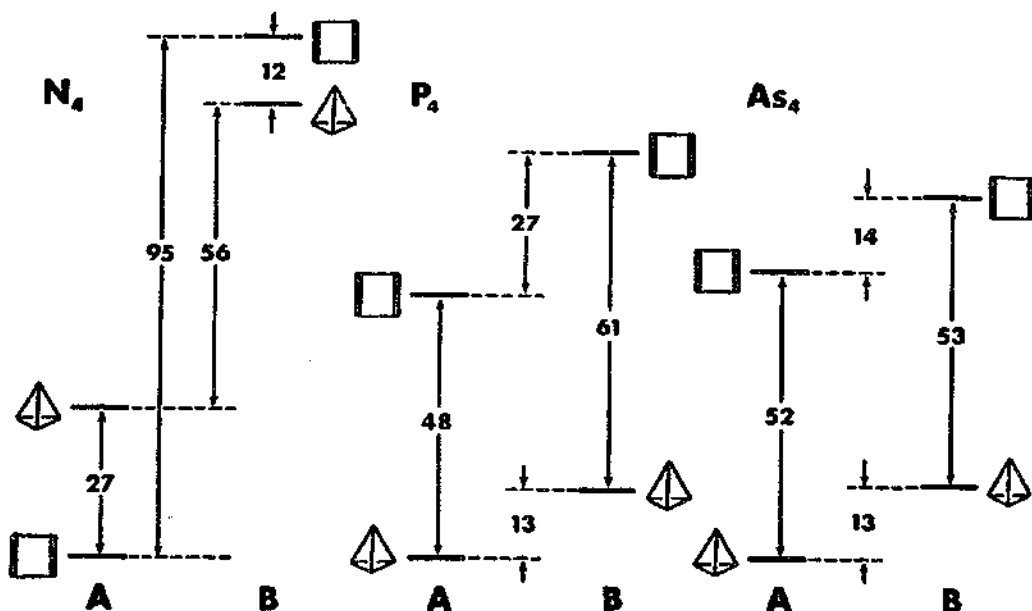

Fig. 5. Relative isomer energies (kcal mol^{-1}) as determined by A, the bond additivity model and energy differences 2Δ of average bond energies; and B, by ab initio calculations of total molecular energies.

As_4 , the strain energies are much smaller than the energy gaps between the two structures at the A level, with the result that strain energies do not alter the relative energies at the ab initio level B; 7 lies above 6 for both As_4 and P_4 .

Fig. 6 compares the energies of tetrahedrane and cyclobutadiene structures for $(\text{CH})_4$ and $(\text{SiH})_4$. At the bond additivity level, A, stronger single bonds give greater stability to the tetrahedron. However, the strain energy of $(\text{CH})_4$ tetrahedrane is enormous, $141 \text{ kcal mol}^{-1}$, compared with the energy gap, $2\Delta = 40 \text{ kcal mol}^{-1}$, between 6 and 7 and even compared with the strain energy of cyclobutadiene, 79 kcal mol^{-1} .

Thus, at the ab initio level, $(\text{CH})_4$ tetrahedrane 6 lies above cyclobutadiene 7. For silicon, 2Δ is large (94 kcal mol^{-1}), the strain energy of $(\text{SiH})_4$ 7 is modest, but the strain energy of $(\text{SiH})_4$ tetrahedrane is about the same as that for $(\text{CH})_4$. The result is that for $(\text{SiH})_4$ the energies of 6 and 7 are quite close at the ab initio level B.

4.2. Six-atom clusters

The benchmark hydrocarbon structures we have chosen for hexatomic homoatomic clusters are the five valence isomers of benzene: the planar regular hexagon or benzene 8, benzvalene 9, Dewar benzene 10, triangular prismane 11, and bicyclopentenyl 12. All five structures have been prepared and characterized, 12 as recently as 1989 [66-70]. The substituted hexasilapolyhedra $(\text{SiR})_6$, where R is a large

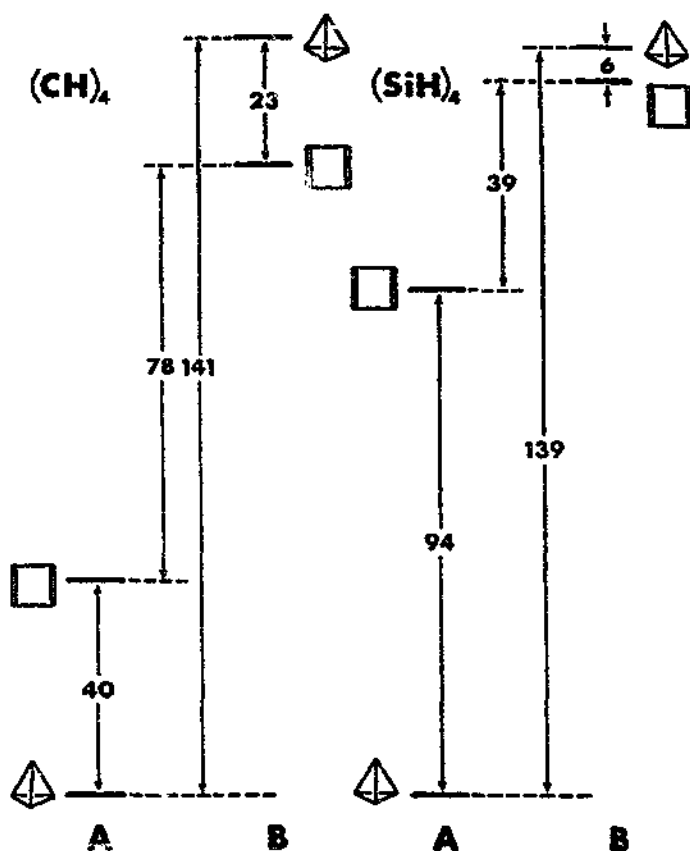

Fig. 6. Relative isomer energies (kcal mol⁻¹) as determined by A, the bond additivity model and energy differences 2Δ of average bond energies; and B, by ab initio calculations of total molecular energies.

protecting group, are represented by **10** and **11** [50,71]. Homoatomic examples of **8–12** involving N, P, or As are unknown.

Fig. 7 displays the relative energies of $(\text{CH})_6$ and $(\text{SiH})_6$ in the forms of the valence isomers of benzene **8–12**; Fig. 8 does the same for N_6 , P_6 and As_6 .

In Fig. 7, the isomers of $(\text{CH})_6$ are arranged in order of increasing energy, with the planar hexagon or benzene **8** at lowest energy at the left and bicyclopropenyl **12** with highest energy on the right. The $(\text{SiH})_6$ structures do not follow this pattern at all. The lowest energy silicon structure is prismane **11**, not benzene **8**. A structure involving a silicon prismane core has actually been prepared, while among carbon isomers, prismane has one of the highest energies. Compared with $(\text{CH})_6$, the silicon isomers span a rather small energy range. Even the hexasilabicyclopropenyl isomer **12** (at just under 60 kcal mol⁻¹ and high compared with the other isomers in this set) has a lower relative energy than any of the higher hydrocarbon isomers.

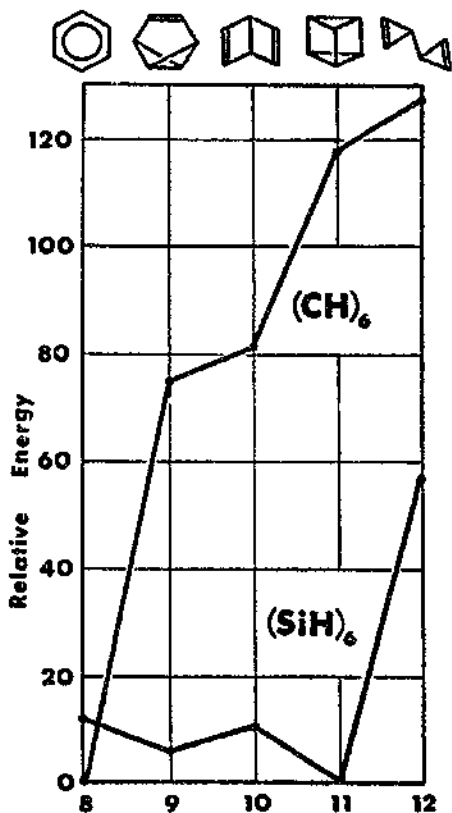

Fig. 7. Relative energies (kcal mol^{-1}) of the valence isomers of benzene as established by ab initio calculations.

The relative energy profile of the N_6 isomers in Fig. 8 has some similarity to that for $(\text{CH})_6$ in Fig. 7, except that the nitrogen forms of Dewar benzene **10** and bicyclopropenyl **12** turn out to have low energies. What these two isomers have in common is a pair of double bonds, reminding us that, in nitrogen systems, double bonds are energetically favored over pairs of single bonds. Indeed, the rule ordering stabilities of N_6 isomers appears to be the number of double bonds, with **8** (three double bonds, at least in the Kekulé form) most stable and **11** (all single bonds) highest in energy. The P_6 and As_6 isomer sets span a small range of relative energies (less than 30 kcal mol^{-1}) compared with those of $(\text{CH})_6$ and N_6 .

The planar hexagonal structure **8** should have sp^2 hybridized ring atoms and 120° bond angles, exactly the value required to establish a planar hexagonal ring. Therefore, we expect **8** to be perfectly strain free. However, benzene is the prototypical example of an aromatic system, with six electrons delocalized around the ring in a set of π MOs conferring resonance stabilization on this structure. The resonance energy of **8** can be calculated as the energy change for a homodesmotic reaction

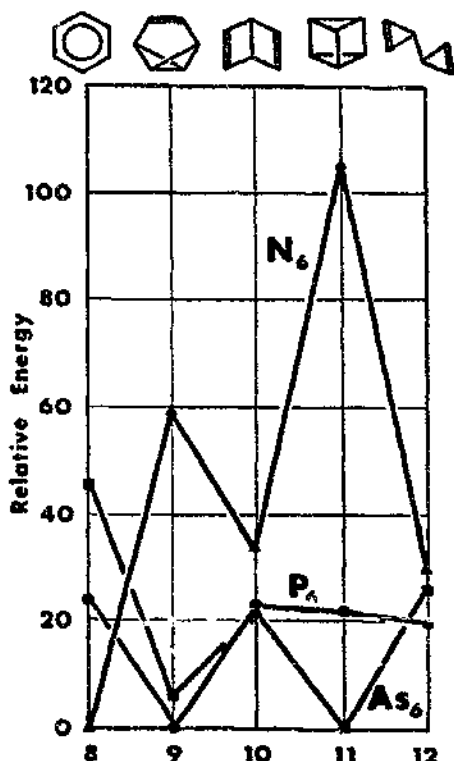
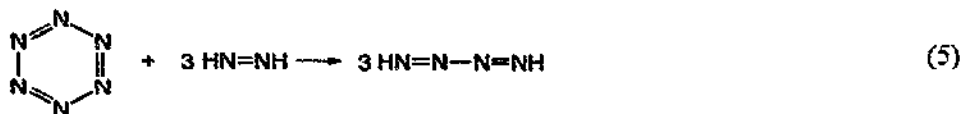

Fig. 8. Relative energies (kcal mol⁻¹) of N₆, P₆, and As₆ analogs of the valence isomers of benzene as determined by ab initio calculations.

that breaks up cyclic delocalization and replaces it by delocalization along a chain. Eq. (5) is such a reaction involving planar hexagonal N₆:



However, structures calculated for **8**, of whatever composition, consist of six equivalent ring bonds, not the alternate system of single and double bonds of the Kekulé structure included in Eq. (5). Therefore, this reaction is not strictly homodesmotic. The product HN=N-N=NH admits the possibility of π electron delocalization along the conjugated double bonds in an attempt to approximate the pattern of delocalization in the ring.

Resonance stabilization of **8** should make Eq. (5) an endothermic reaction, and the corresponding energy change is the resonance energy of **8**. Because we report destabilizing strain energies as positive quantities, we give resonance stabilization energies (Table 4) negative signs. Indeed, results for planar hexagonal forms of (CH)₆, (SiH)₆, P₆, and As₆ all show resonance stabilization. However, Glukhovtsev

and Schleyer [45] have reported that Eq. (5) for N_6 is exothermic; the resonance energy of N_6 **8** is destabilizing or positive. The structures chosen for $HN=NH$ and $HN=N-N=NH$ in Eq. (5) were those of lowest energy: *trans*-HNNH and *cis-trans-cis*-HNNNNH. In these forms, each HNNH should have a pair of trans lone pairs and each HNNNNH should carry a pair of lone pairs trans to each other across the central N–N single bond and two pairs of cis lone pairs on the two N=N double bonds. Since each side of Eq. (5) therefore contains six pairs of cis lone pairs and three pairs of trans lone pairs, the exothermicity of Eq. (5) for N_6 is not a result of different kinds of lone-pair–lone-pair interactions in reactants and products.

Fig. 9 displays the strain energies and resonance energies of the valence isomers **8–12** of $(CH)_6$ and $(SiH)_6$ [22,52]. Although the planar hexagonal isomers **8** of carbon and silicon are both resonance stabilized (by 25 and 15 kcal mol⁻¹ respectively), the magnitudes of these quantities are quite modest compared with the destabilizing effects of strain (64–150 kcal mol⁻¹ for carbon, 26–110 kcal mol⁻¹ for silicon) experienced by the other isomers **9–12**.

If the strain and resonance energy profile of silicon isomers in Fig. 9 is just a damped version of that for the carbon isomers, then why do the two series have

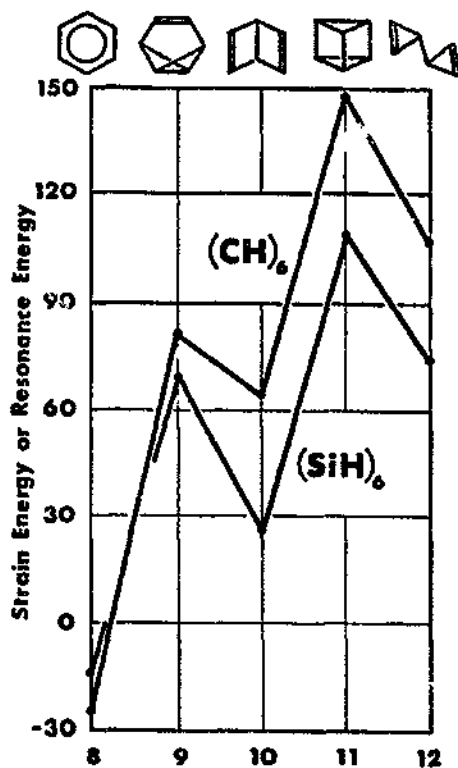

Fig. 9. Calculated strain energies and resonance energies (kcal mol⁻¹) for the valence isomers of benzene. The silicon clusters have strain energies that are diminished versions of those for carbon.

such different patterns of relative energies (Fig. 7)? The bond additivity or localized bond model arranges the relative isomer energies in order of increasing number of double bonds, $11 < 9 < 10$, $12 < 8$, separated by energy increments of Δ . For carbon, $\Delta = 20 \text{ kcal mol}^{-1}$ and the range of isomer energies would be 3Δ . The strain energies of $(\text{CH})_6$ isomers are all larger than 3Δ , and benzene **8**, though indeed stabilized by resonance, would have the lowest energy in the set even if it had no resonance stabilization at all. When corrected for strain, the energies of isomers **9–12** are all pushed far above **8**. For silicon bonds $\Delta = 47 \text{ kcal mol}^{-1}$, over twice the value for carbon. At the bond additivity level, the $(\text{SiH})_6$ isomer energies should span over $140 \text{ kcal mol}^{-1}$, with the planar hexagon **8** at the top and the triangular prism **11** at the bottom. This order is perturbed when strain and resonance energies are included. These quantities are all smaller than the corresponding values for $(\text{CH})_6$. Bicyclopentenyl **12**, with a rather large strain energy (73 kcal mol^{-1}) and at the bond additivity level, lying only 47 kcal mol^{-1} below the planar hexagon **8**, gets pushed to the top of the ab initio energy order. Prismane **11** and benzene **8**, $140 \text{ kcal mol}^{-1}$ apart according to the localized bond model, are repositioned to within 15 kcal mol^{-1} of each other when prismane is destabilized by strain ($+110 \text{ kcal mol}^{-1}$) and benzene is resonance stabilized ($-15 \text{ kcal mol}^{-1}$).

Fig. 10 displays strain and resonance energies of Group 15 clusters N_6 , P_6 , and As_6 in the isomeric forms **8–12** [63–65]. These quantities (recorded in Table 4) have the same profile, with curves at lower energies for elements from the lower rows of the periodic table.

The effects of strain and resonance energies diminishing down a column of the periodic table are what one might expect from electronic structures determined by valence MOs formed from valence AOs of larger principal quantum number. AOs that are larger and more diffuse and which make bonds that are weaker and have lower directional dependence. Even the destabilizing value of the resonance energy of planar hexagonal N_6 seems to fit appropriately into the profile patterns of Fig. 10.

The average bond energy model predicts N_6 isomers to have energies in the order $8 < 10$, $12 < 9 < 11$. As $\Delta = -14 \text{ kcal mol}^{-1}$, structures with larger numbers of double bonds are energetically favored. After corrections with resonance and strain energies, **8** remains at the bottom even though it is resonance destabilized by 20 kcal mol^{-1} , a value much smaller than the strain energies of all the other isomers **9–12**. In fact, the strain energies increase roughly with the number of single bonds, leaving unperturbed the isomer energy order established by the bond additivity model. For P_6 and As_6 , the average bond energy ordering of isomer energies is $11 < 9 < 10$, $12 < 8$ and energy increments, $\Delta \approx 25 \text{ kcal mol}^{-1}$, give an energy range of $3\Delta \approx 75 \text{ kcal mol}^{-1}$. Resonance stabilizations of benzene forms **8** of P_6 and As_6 are modest, ca. 15 kcal mol^{-1} , and even the largest strain energy is much less than 3Δ . These effects produce the rather narrow energy ranges obtained from ab initio calculations for P_6 and As_6 isomers.

4.3. Eight-atom clusters

The benchmark structures we have chosen for eight-atom clusters are cubane **13** and cyclooctatetraene **14**. For $(\text{CH})_8$ both structures have been prepared and charac-

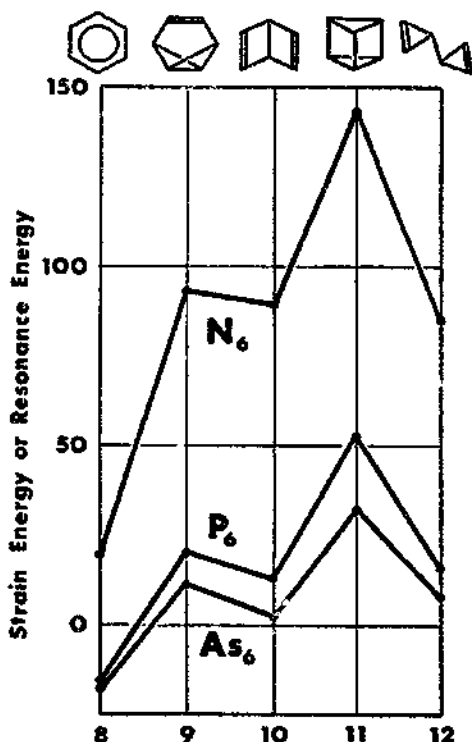

Fig. 10. Calculated strain and resonance energies (kcal mol^{-1}) for N_6 , P_6 , and As_6 analogs of the valence isomers of benzene.

terized [72]. The substituted octasilacubane $(\text{SiR})_8$ has been synthesized and its structure determined by X-ray diffraction [73]. Thermochemical heats of formation for $(\text{CH})_8$ reveal that **14** is more stable than **13** by $77.6 \text{ kcal mol}^{-1}$ [1]. Ab initio calculations show the reverse order of stabilities for $(\text{SiH})_8$ isomers; **13** is more stable than **14** by $89.7 \text{ kcal mol}^{-1}$ [22]. From the bond additivity model we would expect the cubane forms **13** of both $(\text{CH})_8$ and $(\text{SiH})_8$ to have lower energies than their corresponding cyclooctatetraenes **14** because the cubanes contain single bonds only. With four $\text{C}=\text{C}$ double bonds, $(\text{CH})_8$ should be $4\Delta = 80 \text{ kcal mol}^{-1}$ higher in energy than **13**. For silicon bonds, Δ is more than twice that of carbon bonds and the bond additivity rule predicts $(\text{SiH})_8$ **14** to be $4\Delta = 188 \text{ kcal mol}^{-1}$ above **13**. Strain energies of cyclooctatetraene forms **14** are negligible for both $(\text{CH})_8$ and $(\text{SiH})_8$. However, the cubane structures have large strain energies, $165 \text{ kcal mol}^{-1}$ for $(\text{CH})_8$ and $94.5 \text{ kcal mol}^{-1}$ for $(\text{SiH})_8$. Strain in $(\text{CH})_8$ **13** raises the energy of this structure by more than 4Δ , and therefore well above the energy of **14**, to give the observed energy order for the carbon isomers. The strain energy of $(\text{SiH})_8$ cubane is smaller than that for the hydrocarbon analog, while 4Δ is much larger. Strain destabilization of $(\text{SiH})_8$ **13** is not enough to push the energy of cubane above

that of cyclooctatetraene and the relative isomer energy order set by the bond energy differences is maintained.

Ab initio calculations for N_8 place **14** lower in energy than **13** by $180.6 \text{ kcal mol}^{-1}$ [65]. This order is qualitatively consistent with the bond additivity model that favors **14** by $4\Delta = 56 \text{ kcal mol}^{-1}$. The N_8 cyclooctatetraene structure **14** has a large strain energy, $92.8 \text{ kcal mol}^{-1}$, and the strain energy of cubane **13** is even larger, $219.4 \text{ kcal mol}^{-1}$. In the structure calculated for **14**, NNN bond angles do not deviate widely from the value of 120° preferred by sp^2 hybridized nitrogen. We attribute the large strain energy of N_8 **14** not to angle strain but to dihedral angles that do not allow optimal conformational arrangement of the nitrogen electron lone pairs. Relative sizes of strain energies and bond type energy differences both favor **14** for N_8 .

Leininger et al. have proposed the N_8 structure **15**, which they found to have considerably lower energy than either **13** or **14** [74]. Structure **15** is not an analog of one of the $(CH)_8$ valence isomers. Instead, N_8 **15** should be compared with the isostructural, isoelectronic pentalene dianion, $C_8H_6^{2-}$, which is known to be aromatic [75,76]. Indeed, ab initio calculations for **15** yield a stabilizing resonance energy of $-20 \text{ kcal mol}^{-1}$ [65]. Recall that N_6 **8** has a calculated resonance energy that is destabilizing, $+20 \text{ kcal mol}^{-1}$ [45].

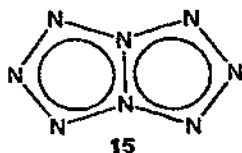
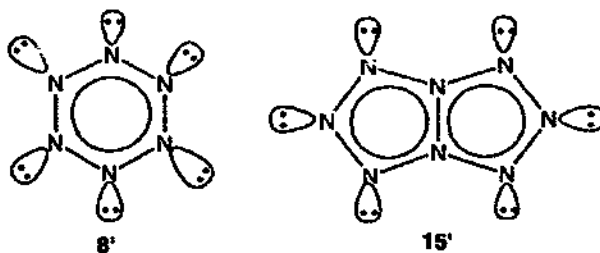

Fig. 11 compares the calculated resonance energies of N_6 **8** and N_8 **15** with the same quantities for the aromatic hydrocarbons $(CH)_6$, benzene, and $C_8H_6^{2-}$, pentalene dianion [77]. This figure reveals two significant differences between the hydrocarbon and nitrogen systems: (i) the hydrocarbons are much more effectively stabilized by resonance than are the nitrogen clusters; (ii) the gap between resonance energies of the two nitrogen molecules is twice that between the comparable aromatic hydrocarbons. We propose the following arguments to rationalize these differences.

Among carbon systems, pairs of single bonds are energetically preferred to double bonds. An electronic structural reorganization that shifts away from double bonds should be favorable. The reverse is true for nitrogen, with the result that resonance



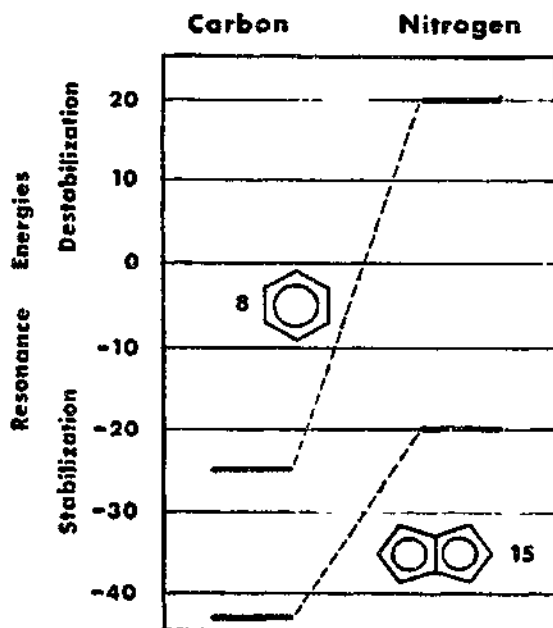

Fig. 11. Resonance energies (kcal mol^{-1}) for aromatic hydrocarbon and nitrogen clusters. Resonance stabilization of the hydrocarbons is much greater than that for the hypothetical nitrogen analogs. The energy gap between **8** and **15** is much larger for nitrogen clusters than for the hydrocarbons.

in conjugated nitrogen systems might not be stabilizing. The large energy gap between resonance energies of N_6 **8** and N_8 **15** may be due to differences in numbers and effectiveness of lone-pair–lone-pair repulsions. Each structure, **8'** and **15'**, has six lone pairs, but **15'** has only four sets of nearest neighbor lone-pair–lone-pair repulsions, and **8'** has six sets. Furthermore, smaller interior angles in the five-membered rings of **15'** point the lone pairs farther apart than those around the six-membered ring **8'**. These effects should produce a larger splitting between resonance energies of N_6 **8** and N_8 **15** compared with benzene and the pentalene dianion which have no lone pairs.

5. Additivity rule for ring strain energies

The ring strain additivity rule states that the strain energy of a polycyclic or polyhedral molecule can be estimated by summing the strain energies of the individual rings that comprise the larger structure [3,78,79]. The rule has been quite successfully applied in organic chemistry where strain energies of rings and clusters are widely known. For example, the strain energies of the cycloalkanes $(\text{CH}_2)_3$ and $(\text{CH}_2)_4$ are $30.6 \text{ kcal mol}^{-1}$ and $28.3 \text{ kcal mol}^{-1}$ respectively. Tetrahedrane **6** is composed of four three-membered rings. Therefore, the strain energy of $(\text{CH})_4$ **6**

should be $4 \times 30.6 = 122.4 \text{ kcal mol}^{-1}$; a result that is within about 10% of the value $141 \text{ kcal mol}^{-1}$ calculated directly as the energy change of a homodesmotic reaction, comparable with Eq. (3), that converts tetrahedrane into branched chain products. The strain energy of cubane **13**, with six square faces, should be approximately $6 \times 28.3 = 170 \text{ kcal mol}^{-1}$ — quite close to the value $166 \text{ kcal mol}^{-1}$ for $(\text{CH})_6$ **13**. Prismane **11** has two triangular faces and three square faces. The ring additivity rule estimate of the prismane strain energy is $2 \times 30.6 + 3 \times 28.3 = 146.1 \text{ kcal mol}^{-1}$, compared with the value $149 \text{ kcal mol}^{-1}$ as calculated directly. The rule works well for clusters with rings containing double bonds. Bicyclopropenyl **12** should have twice the strain energy of cyclopropene: $2 \times 54.5 = 109 \text{ kcal mol}^{-1}$, compared with the direct value of $107 \text{ kcal mol}^{-1}$. Dewar benzene **10** should have twice the strain energy of cyclobutene: $2 \times 30.6 = 61.2 \text{ kcal mol}^{-1}$, compared with $63.6 \text{ kcal mol}^{-1}$ from Table 4. Benzvalene **9** can be considered to be composed of two cyclopropanes and two cyclopentenes: $2 \times 30.6 + 2 \times 6.8 = 75 \text{ kcal mol}^{-1}$, compared with $81.3 \text{ kcal mol}^{-1}$ from a homodesmotic reaction energy change. Bicyclobutane **16** consists of two three-membered rings; the additivity rule gives $2 \times 30.6 = 61.2 \text{ kcal mol}^{-1}$ as the strain energy compared with the direct value of $66.5 \text{ kcal mol}^{-1}$.

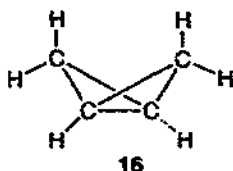

Benzvalene **9** contains a bicyclobutane fragment **16**, and the strain energy of **9** can be calculated alternatively as the strain energy of **16** plus twice that of cyclopentene: $66.5 + 2 \times 6.8 = 80.1 \text{ kcal mol}^{-1}$; an even closer approximation to the directly calculated value of $81.3 \text{ kcal mol}^{-1}$. These examples demonstrate the extent and level of applicability of the ring strain additivity rule, at least for hydrocarbons. We now have available enough data to show how well the rule works for inorganic homoatomic clusters.

5.1. Strain energy additivity in silicon clusters

The polyhedral silanes provide the closest inorganic comparisons with the hydrocarbon examples for the use of the strain energy additivity rule. For $(\text{SiH})_4$ tetrahedrane **6**, the strain energy rule gives $4 \times 38.3 = 153 \text{ kcal mol}^{-1}$; only 10% larger than the energy change for a strain energy releasing homodesmotic reaction, $139 \text{ kcal mol}^{-1}$ (Table 4). For $(\text{SiH})_6$ cubane **13**, the rule gives $102 \text{ kcal mol}^{-1}$ compared with $115 \text{ kcal mol}^{-1}$ directly. Prismane **11** can be approximated by an additivity rule value of $128 \text{ kcal mol}^{-1}$ ($120.3 \text{ kcal mol}^{-1}$, Table 4). For bicyclopropenyl **12** and Dewar benzene **10**, the additivity rule gives strain energies for silicon clusters that are quite close to those directly calculated (in parentheses), 74.4 (72.5) kcal mol^{-1} and 25.2 (26.2) kcal mol^{-1} respectively. Less satisfactory is the additivity estimate for Si_4H_6 bicyclobutane **16**: $2 \times 38.6 = 77.2 \text{ kcal mol}^{-1}$ (vs.

54 kcal mol⁻¹). Two estimates of the strain energy of (SiH)₆ benzvalene **9** rather widely bracket the directly calculated value, 68.7 kcal mol⁻¹. For **9**, two cyclopropanes plus two cyclopentenes give 80.8 kcal mol⁻¹, while bicyclobutane plus two cyclopentenes yield 58.2 kcal mol⁻¹. These examples demonstrate that the ring strain additivity rule applies to silicon clusters, though perhaps with some reservations.

5.2. Strain energy additivity in Group 15 clusters

In analogy to (CH)₄ tetrahedrane **6**, we would expect to be able to estimate the strain energy of N₄ tetrahedrane as four times the strain energy of the (NH)₃ ring. Taking the value from Table 2, we get 4 × 30.1 = 120.4 kcal mol⁻¹, a quantity that is unacceptably large compared with the directly calculated result of 56.1 kcal mol⁻¹ in Table 4. Similarly, the strain energy of N₈ cubane **13** should be 6 × 37.2 kcal mol⁻¹, a result that is again too large. In selecting ring strain energies from Table 2 we have neglected to consider appropriate conformations of the three- and four-membered rings that represent faces of the polyhedra. Fig. 12 shows the disposition of lone pairs around tetrahedral N₄ and cubic N₈ and the corresponding rings (NH)₃ and (NH)₄ that have the same lone pair and bond orientations as the polyhedral faces they are expected to represent.

Compared with **1** and **2**, the conformations of three- and four-membered rings in Fig. 12 have even higher strain energies (42.0 kcal mol⁻¹ and 57.8 kcal mol⁻¹ respectively). These values give even higher strain energy estimates for tetrahedral N₄ and cubic N₈. The error comes from counting too many lone-pair–lone-pair repulsions. The tetrahedron has six edges and therefore six sets of lone-pair–lone-pair repulsions. Each three-membered ring of the conformation featured in Fig. 12 has three sets of lone-pair–lone-pair repulsions and four such rings introduce 12 sets of repulsions; twice the number present in the tetrahedron. The cube has 12 edges and 12 sets of

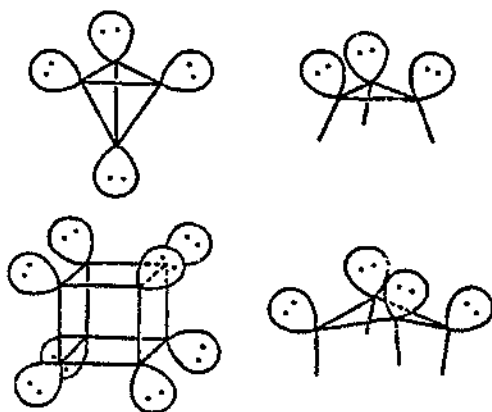

Fig. 12. Disposition of lone pairs of electrons around tetrahedral N₄ and cubic N₈ and their corresponding (NH)₃ and (NH)₄ rings. The monocycles are not in their lowest energy conformations.

nearest neighbor lone pair repulsions, and six four-membered rings of the conformation of Fig. 12 present 24 sets of nearest neighbor repulsions.

An alternative approach to ring strain additivity for Group 15 clusters is to apply the additivity rule in reverse [63]: take the strain energy of a regular polyhedron, divide it by the number of faces, and get a cluster component ring strain energy. Thus, the strain energy of each of the four three-membered rings of the N_4 tetrahedron is $56.1 \div 4 = 14.0 \text{ kcal mol}^{-1}$. Similarly, the strain energy of each four-membered ring in the N_8 cube is $219.4 \div 6 = 36.6 \text{ kcal mol}^{-1}$. With these cluster component ring strain energies, the additivity rule can be used again to estimate the strain energy of the N_6 triangular prism **11** as composed of two three-membered rings and three four-membered rings: $2 \times 14.0 + 3 \times 36.6 = 137.8 \text{ kcal mol}^{-1}$; a result that compares quite favorably with the value $144.1 \text{ kcal mol}^{-1}$ as calculated directly and reported in Table 4. Similar decompositions of phosphorus and arsenic tetrahedra and cubes give cluster component three- and four-membered ring strain energies that yield good estimates of strain energies for the corresponding triangular prisms. We conclude that the additivity rule applies to Group 15 polyhedra if, for individual rings, we use cluster component ring strain energies that average the effects of lone pair repulsions over contiguous polyhedral faces.

The choice of strain-free reference structures might also contribute to making cluster component ring strain energies smaller than those obtained for individual monocycles. Homodesmotic reactions comparable with that in Eq. (1) convert monocycles into unbranched chains. Homodesmotic reactions, such as that in Eq. (4), relieve the strain of polyhedral clusters by converting them into branched chain products which might themselves be somewhat strained, giving smaller energy changes to these homodesmotic reactions. Group 15 branched reference structures must involve deviations from preferred bond angles, as well as the spatial orientation of nearest neighbor and non-nearest-neighbor lone-pair–lone-pair repulsions.

The additivity rule gives acceptable estimates of strain energies in N_6 and P_6 clusters **10** and **12** using the strain energies of rings in conformations **3** and **4b** (Table 2).

6. Summary

According to the bond additivity or localized bond model, the relative energies of homoatomic structural isomers are arranged and spaced by energy differences between double bonds and pairs of single bonds. Carbon, silicon, and nitrogen are examples of elements that present quite different bond parameters that determine the energy order and energy spacing among structural isomers. Ab initio calculations and experiment (in the case of hydrocarbons) reveal energy order and spacing of isomers quite different from that expected from the bond additivity model.

Strain and resonance have been important concepts in organic chemistry, correcting for failures of the localized bond model. Only recently have estimates of the corresponding parameters become available for isoelectronic and isostructural inorganic analogs. Cluster strain energies are invariably destabilizing quantities. In the

examples presented here, cluster strain energies range from negligible to over 200 kcal mol⁻¹. In comparison, resonance energies are much more modest, providing no more than 25 kcal mol⁻¹ in stabilization and, for planar hexagonal N₆, the resonance energy is destabilizing but by only 20 kcal mol⁻¹. Among a set of structural isomers that exhibit both strain and resonance, strain dominates. The results reviewed here show that homoatomic clusters of elements of the lower rows of the periodic table have strain energies that are smaller, and usually much smaller, than those of the isostructural hydrocarbon and nitrogen clusters.

Calculated strain energies of inorganic monocycles are now available for comparison with those for cycloalkanes and cycloalkenes. The ring strain additivity rule appears to operate for inorganic clusters as well as it does for hydrocarbons, although for inorganic examples the effects of lone pair repulsions are large and must be considered. However, once such differences are appreciated, the strain energies of monocycles or cluster component rings can be used to correct the bond additivity energy order and rationalize the relative stabilities among sets of isomeric structures.

Although few inorganic clusters have been prepared in the forms of the benchmark hydrocarbon structures considered here, many examples of polyhedral, homoatomic, but ionic, clusters have been prepared from Group 14 and 15 elements of the lower periods. Calculations of strain and resonance energies for ionic species are more complicated because they involve energy changes for reactions that separate charges or distribute charges over product fragments of different lengths or arrangements. How strain and resonance energies determine the relative stabilities of homoatomic ionic clusters is a subject of continuing research.

Acknowledgements

Our former colleague, D. Scott Warren, worked with us earlier on the calculation of strain energies of inorganic homoatomic clusters. We are grateful for his insights as well as his calculated results during the initial stages of this research [80]. We acknowledge the partial support during the early part of this research by the National Science Foundation through Grant CHE-9012216 to the University of South Carolina.

References

- [1] J.D. Cox and G. Pilcher, *Thermochemistry of Organic and Organometallic Compounds*, Academic Press, New York, 1970.
- [2] R.T. Sanderson, *Chemical Bonds and Bond Energy*, Academic Press, New York, 1976.
- [3] A. Greenberg and J.F. Liebman, *Strained Organic Molecules*, Academic Press, New York, 1978.
- [4] U. Berkert and N.L. Allinger, *Molecular Mechanics [ACS Monograph 177]*, American Chemical Society, Washington, DC, 1982.
- [5] P.v.R. Schleyer, J.E. Williams and K.R. Blanchard, *J. Am. Chem. Soc.*, 92 (1970) 2377.
- [6] K.B. Wiberg, *Angew. Chem. Int. Ed. Engl.*, 25 (1986) 312.
- [7] D. Lewis and D. Peters, *Facts and Theories of Aromaticity*, Macmillan, London, 1975.

- [8] P.J. Garratt, *Aromaticity*, Wiley, New York, 1986.
- [9] V.I. Minkin, M.N. Glukhovtsev and B.Ya. Simkin, *Aromaticity and Antiaromaticity: Electronic and Structural Aspects*, Wiley, New York, 1994.
- [10] W.J. Hehre, L. Radom, P.v.R. Schleyer and J.A. Pople, *Ab Initio Molecular Orbital Theory*, Wiley, New York, 1986.
- [11] M.J. Frisch, G.W. Trucks, M. Head-Gordon, P.M.W. Gill, M.W. Wong, J.B. Foresman, B.G. Johnson, H.B. Schlegel, M.A. Robb, E.S. Replogle, R. Gomperts, J.L. Andres, K. Raghavachari, J.S. Binkley, C. Gonzales, R.L. Martin, D.J. Fox, D.J. Defrees, J. Baker, J.J.P. Stewart and J.A. Pople, *GAUSSIAN 92, Revision C.4*, Gaussian, Inc., Pittsburgh, 1992.
- [12] P. George, M. Trachtman, A.M. Brett and C.W. Bock, *J. Chem. Soc. Perkin Trans. 2*, (1977) 1036.
- [13] P. George, M. Trachtman, C.W. Bock and A.M. Brett, *J. Chem. Soc. Perkin Trans. 2*, (1976) 1222.
- [14] P. George, M. Trachtman, C.W. Bock and A.M. Brett, *Tetrahedron*, 32 (1976) 317.
- [15] R.L. Disch, J.M. Schulman and M.L. Sabio, *J. Am. Chem. Soc.*, 107 (1985) 1904.
- [16] B.A. Hess and L.J. Schaad, *J. Am. Chem. Soc.*, 105 (1983) 7500.
- [17] D.S. Warren and B.M. Gimarc, *J. Phys. Chem.*, 97 (1993) 4031.
- [18] M. Zhao and B.M. Gimarc, *J. Phys. Chem.*, 97 (1993) 4023.
- [19] B.M. Gimarc and M. Zhao, *J. Phys. Chem.*, 98 (1994) 1596.
- [20] M. Zhao and B.M. Gimarc, *J. Phys. Chem.*, 98 (1994) 7491.
- [21] B.M. Gimarc and M. Zhao, *Phosphorus Sulfur Silicon*, 93-94 (1994) 231.
- [22] M. Zhao and B.M. Gimarc, *Inorg. Chem.*, in press.
- [23] K.C. Mills, *Thermodynamic Data for Inorganic Sulphides, Selenides, and Tellurides*, Butterworth, London, 1974, pp. 71-77; 348.
- [24] H. Rau, T.R.N. Kutty and J.R.F. Guedes de Carvalho, *Chem. Thermodyn.*, 5 (1973) 833.
- [25] F. Fehér and G. Winkhaus, *Z. Anorg. Allg. Chem.*, 292 (1957) 210.
- [26] M. Baudler, *Angew. Chem. Int. Ed. Engl.*, 26 (1987) 419.
- [27] M. Baudler and G. Glinka, *Chem. Rev.*, 93 (1993) 1623.
- [28] W. Rosinger, M. Grade and W. Hirschwald, *Ber. Bunsenges. Phys. Chem.*, 87 (1983) 536.
- [29] J. Steidel, J. Pickardt, and R. Stedel, *Z. Naturforsch. Teil B*, 33 (1978) 1554.
- [30] J. Donohue, *J. Cryst. Mol. Struct.*, 8 (1978) 141.
- [31] R. Steudel and F. Schuster, *J. Mol. Struct.*, 44 (1978) 143.
- [32] R. Steudel, R. Reinhardt and F. Schuster, *Angew. Chem. Int. Ed. Engl.*, 16 (1977) 715.
- [33] R. Steudel, J. Steidel, J. Pickardt, F. Schuster and R. Reinhardt, *Z. Naturforsch. Teil B*, 35 (1980) 1378.
- [34] A. Caron and J. Donohue, *Acta Crystallogr.*, 18 (1965) 562.
- [35] G.S. Pawley and R.P. Rinaldi, *Acta Crystallogr. Sect. B*, 28 (1972) 3605.
- [36] Y. Watanabe, *Acta Crystallogr. Sect. B*, 30 (1974) 1396.
- [37] P. Coppens, Y.W. Yang, R.H. Blessing, W.F. Cooper and F.K. Larsen, *J. Am. Chem. Soc.* 99 (1977) 760.
- [38] H. Watanabe, H. Shimoyama, T. Muroaka and T. Okawa, *Chem. Lett.*, (1986) 1057.
- [39] S. Wolfe, *Acc. Chem. Res.*, 5 (1972) 102.
- [40] A.T. Balaban, *Rev. Roum. Chim.*, 11 (1966) 1097.
- [41] B.A. Hess and L.J. Schaad, *J. Am. Chem. Soc.*, 107 (1985) 864.
- [42] M.N. Glukhovtsev and P.v.R. Schleyer, *Int. J. Quantum Chem.*, 46 (1993) 119.
- [43] B.F. Yates, D.A. Clabo and H.F. Schaefer, III, *Chem. Phys. Lett.*, 143 (1988) 421.
- [44] S. Nagase and M. Nakano, *Angew. Chem. Int. Ed. Engl.*, 27 (1988) 1081.
- [45] M.N. Glukhovtsev and P.v.R. Schleyer, *Chem. Phys. Lett.*, 198 (1992) 547.
- [46] R. Engelke, *J. Phys. Chem.*, 93 (1989) 5722.
- [47] R. Engelke, *J. Phys. Chem.*, 96 (1992) 10789.
- [48] A.F. Sax, J. Kalcher and R. Janoschek, *J. Comput. Chem.*, 9 (1988) 564.
- [49] S. Nagase, H. Teramae and T. Kudo, *J. Chem. Phys.*, 86 (1987) 4513.
- [50] A. Sekiguchi, T. Yataba, S. Doi and H. Sakurai, *Phosphorus Sulfur Silicon*, 93-94 (1994) 193.
- [51] W.W. Schoeller, J. Tabisch and T. Busch, *Inorg. Chem.*, 26 (1987) 4383.
- [52] J.M. Schulman and R.L. Disch, *J. Am. Chem. Soc.*, 107 (1985) 5059.
- [53] J.M. Schulman and T.J. Venanzi, *J. Am. Chem. Soc.*, 96 (1974) 4739.

- [54] S. Nagase, *Angew. Chem. Int. Ed. Engl.*, 28 (1989) 329.
- [55] G. Maier, *Angew. Chem. Int. Ed. Engl.*, 27 (1988) 309.
- [56] J.D. Dunitz, C. Krüger, H. Irngartinger, E.F. Maverick, Y. Wang and M. Nixdorf, *Angew. Chem. Int. Ed. Engl.*, 27 (1988) 387.
- [57] L.R. Maxwell, S.B. Hendricks and V.M. Mosley, *J. Chem. Phys.*, 3 (1935) 699.
- [58] Y. Morino, T. Ukaji and T. Ito, *Bull. Chem. Soc. Jpn.*, 39 (1966) 64.
- [59] V.E. Bondybey, G.P. Schwartz and J.E. Girffiths, *J. Mol. Spectrosc.*, 89 (1981) 328.
- [60] K. Manzel, Y. Engelhardt, H. Abe, W. Schulze and F.W. Froben, *Chem. Phys. Lett.*, 77 (1981) 514.
- [61] D.L. Reger, S.R. Goode and E.E. Mercer, *Chemistry: Principles and Practice*, Saunders, New York, 1993.
- [62] D.S. Warren and B.M. Gimarc, *J. Am. Chem. Soc.*, 114 (1992) 5378.
- [63] B.M. Gimarc and D.S. Warren, *Inorg. Chem.*, 32 (1993) 1850.
- [64] D.S. Warren, B.M. Gimarc and M. Zhao, *Inorg. Chem.*, 33 (1994) 710.
- [65] B.M. Gimarc and M. Zhao, *Inorg. Chem.*, 35 (1996) 3289.
- [66] E.E. Van Tamelen and S.P. Pappas, *J. Am. Chem. Soc.*, 84 (1962) 3789; 85 (1963) 3297.
- [67] K.E. Wilzbach, J.S. Ritscher and L. Kaplan, *J. Am. Chem. Soc.*, 89 (1967) 1031.
- [68] T.J. Katz and N. Acton, *J. Am. Chem. Soc.*, 95 (1973) 2738.
- [69] W.E. Billups and M.M. Haley, *Angew. Chem. Int. Ed. Engl.*, 28 (1989) 1711.
- [70] R. Boese, D. Bläser, R. Gleiter, K.-H. Pfeifer, W.E. Billups and M.M. Haley, *J. Am. Chem. Soc.*, 115 (1983) 743.
- [71] A. Sekiguchi, T. Yatabe, C. Kabuto, and H. Sakurai, *J. Am. Chem. Soc.*, 115 (1993) 5853.
- [72] P.E. Eaton and T.W. Cole, Jr., *J. Am. Chem. Soc.*, 86 (1964) 3157.
- [73] A. Sekiguchi, T. Yatabe, H. Kamatai, C. Kabuto and H. Sakurai, *J. Am. Chem. Soc.*, 114 (1992) 6260.
- [74] M.L. Leininger, C.D. Sherrill and H.F. Schaefer, III, *J. Phys. Chem.*, 99 (1995) 2324.
- [75] T.J. Katz and M. Rosenberger, *J. Am. Chem. Soc.*, 84 (1962) 865.
- [76] B.M. Gimarc, *J. Am. Chem. Soc.*, 105 (1983) 1979.
- [77] I. Gutman, M. Milun and N. Trinajstić, *J. Am. Chem. Soc.*, 99 (1977) 1692.
- [78] S.W. Benson, *Thermochemical Kinetics*, Wiley, New York, 2nd edn., 1976.
- [79] K. Hassenrück, H.-D. Martin and R. Walsh, *Chem. Rev.*, 89 (1989) 1125.
- [80] B.M. Gimarc and D.S. Warren, *Croat. Chem. Acta*, 67 (1994) 125.